

### HIGH-TEMPERATURE, 40V N-CHANNEL POWER MOSFET FAMILY

#### FEATURES

- ▲ Minimum  $BV_{DSS} = 55V$ .
- ▲ Allowed  $V_{GS}$  range  $-5.5V$  to  $+5.5V$ .
- ▲ Operational beyond the  $-60^{\circ}C$  to  $+230^{\circ}C$  temperature range.
- ▲ Low  $R_{DS(on)}$ 
  - XTR2N0425: 560 m $\Omega$  @ 230 $^{\circ}C$
  - XTR2N0450: 255 m $\Omega$  @ 230 $^{\circ}C$
- ▲ Maximum  $I_D$ :
  - XTR2N0425: 4.7A @ 230 $^{\circ}C$
  - XTR2N0450: 10.3A @ 230 $^{\circ}C$
- ▲ On-time ( $t_{d(on)}+t_r$ ):
  - XTR2N0425: 25nsec @ 230 $^{\circ}C$
  - XTR2N0450: 30nsec @ 230 $^{\circ}C$
- ▲ Off-time ( $t_{d(off)}+t_f$ ):
  - XTR2N0425: 56nsec @ 230 $^{\circ}C$
  - XTR2N0450: 68nsec @ 230 $^{\circ}C$
- ▲ Ruggedized 3-lead TO257, 8-lead side brazed DIP and 8-lead SOIC with ePAD.
- ▲ Also available as bare die.

#### DESCRIPTION

XTR2N0400 is a family of N-channel power MOSFETs designed to reliably operate over a wide range of temperatures. Full functionality is guaranteed from  $-60^{\circ}C$  to  $+230^{\circ}C$ , though operation well below and above this temperature range is achieved. Fabricated on a Silicon-on-Insulator (SOI) process, XTR2N0400 family parts offer reduced leakage currents while providing high drain currents a low  $R_{DS(on)}$ . These features allow XTR2N0400 parts to be ideally suited for switching applications. XTR2N0400 family parts have been designed to reduce system cost and ease adoption by reducing the learning curve and providing smart and easy to use features. Parts from the XTR2N0400 family are available in ruggedized 3-lead TO257, 8-lead side brazed DIP and 8-lead SOIC with ePAD. Parts are also available as tested bare die.

#### APPLICATIONS

- ▲ Reliability-critical, Automotive, Aeronautics & Aerospace, Down-hole.
- ▲ DC/DC converters, power switching, motor control, power inverters, power linear regulators, power supply.

#### PRODUCT HIGHLIGHT

Power Series Regulator

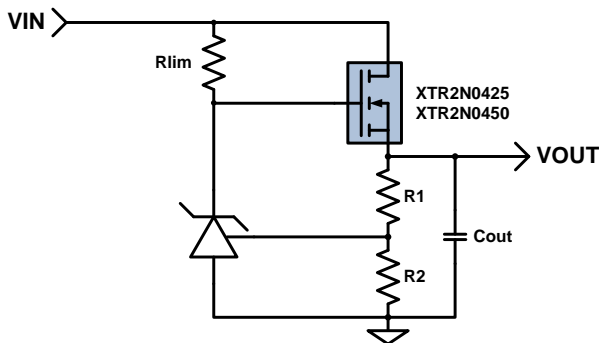

Step-down DC-DC Converter

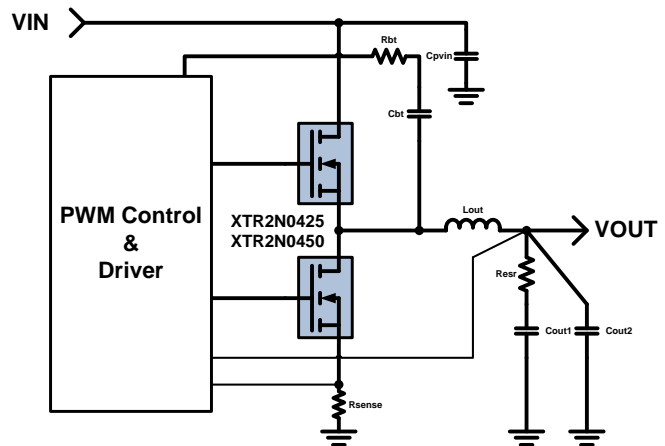

#### ORDERING INFORMATION

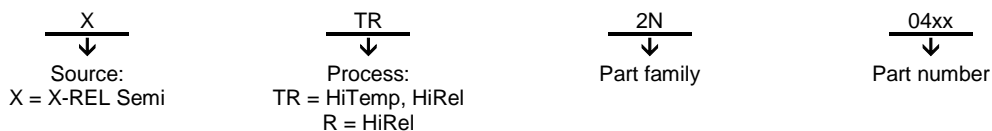

Product Reference	Temperature Range	Package	Pin Count	Marking
XTR2N0425-TD	$-60^{\circ}C$ to $+230^{\circ}C$	Tested bare die		XTR2N0425
XTR2N0450-TD	$-60^{\circ}C$ to $+230^{\circ}C$	Tested bare die		XTR2N0450
XTR2N0425-D	$-60^{\circ}C$ to $+230^{\circ}C$	Ceramic side Braze DIP	8	XTR2N0425
XTR2N0425-FE	$-60^{\circ}C$ to $+230^{\circ}C$	Gull-wing flat pack with ePad	8	XTR2N0425
XTR2N0425-T	$-60^{\circ}C$ to $+230^{\circ}C$	TO-257AA	3	XTR2N0425
XTR2N0450-T	$-60^{\circ}C$ to $+230^{\circ}C$	TO-257AA	3	XTR2N0450

Other packages and packaging configurations possible upon request. For some packages or packaging configurations, MOQ may apply.

## ABSOLUTE MAXIMUM RATINGS

Drain-source voltage	-2V to +55V
Gate-source voltage	±6.0V
Storage temperature range	-70°C to +230°C
Operating junction temperature range	-70°C to +300°C
ESD classification	2kV HBM MIL-STD-750

**Caution:** Stresses beyond those listed in “ABSOLUTE MAXIMUM RATINGS” may cause permanent damage to the device. These are stress ratings only and functionality of the device at these or any other condition beyond those indicated in the operational sections of the specifications is not implied. Exposure to “ABSOLUTE MAXIMUM RATINGS” conditions for extended periods may permanently affect device reliability.

## PRODUCT VARIANTS

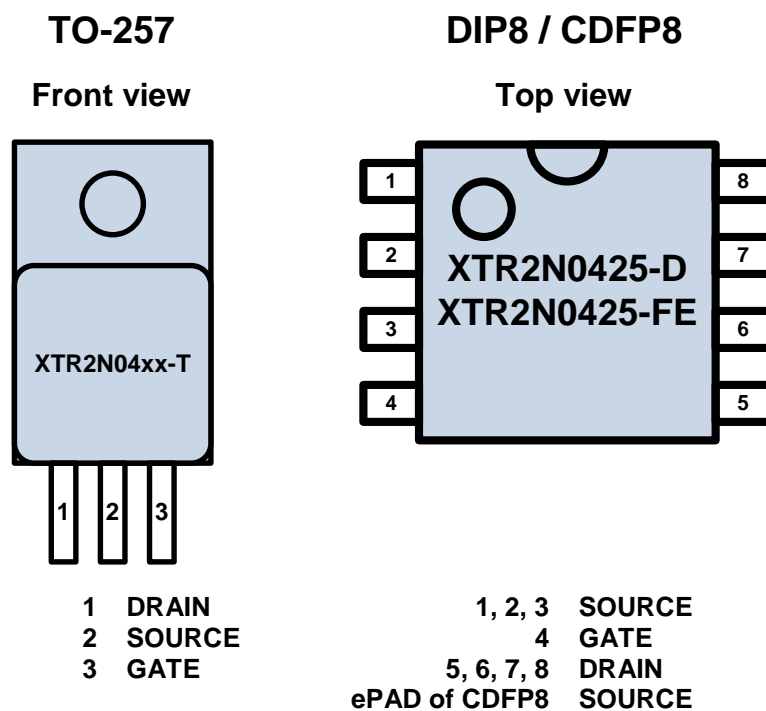

## THERMAL CHARACTERISTICS

Parameter	Condition	Min	Typ	Max	Units
<b>XTR2N04xx-T (TO257)</b>					
Thermal Resistance: J-C $R_{Th, J-C}$			5		°C/W
Thermal Resistance: J-A $R_{Th, J-A}$	Still air.		50		°C/W
<b>XTR2N0425-D (DIP8)</b>					
Thermal Resistance: J-C $R_{Th, J-C}$			20		°C/W
Thermal Resistance: J-A $R_{Th, J-A}$	Still air.		100		°C/W
<b>XTR2N0425-FE (DFP8 with exposed pad)</b>					
Thermal Resistance: J-C $R_{Th, J-C}$	Measured on ePAD.		7		°C/W
Thermal Resistance: J-A $R_{Th, J-A}$	ePAD thermally connected to 3cm <sup>2</sup> PCB copper		70		°C/W

**RECOMMENDED OPERATING CONDITIONS**

Parameter	Min	Typ	Max	Units
Drain-source voltage $V_{DS}$	-1.5		40	V
Gate-source voltage $V_{GS}$	-5.5		+5.5	V
Junction Temperature <sup>1</sup> $T_j$	-60		230	°C

<sup>1</sup> Operation beyond the specified temperature range is achieved. The -60°C to +230°C range for the case temperature is considered for the case where  $I_D \leq I_{D(DC)}$  for a given case temperature.

**XTR2N0425 SPECIFICATIONS**

Unless otherwise stated, specification applies for -60°C <  $T_j$  < 230°C.

Parameter	Condition	Min	Typ	Max	Units
<b>DC Characteristics</b>					
Drain-source breakdown voltage $BV_{DSS}$	$V_{GS}=0V, I_{DS}=100\mu A$	55			V
Static drain-source on-state resistance $R_{DS(on)}$	$V_{GS}=+5V, I_{DS}=100mA$ $T_C=-60^\circ C$ $T_C=85^\circ C$ $T_C=230^\circ C$		230 360 560	280 430 670	mΩ
Continuous drain current $I_{D(DC)}$	$V_{GS}=+5V$ for TO-257 $T_J=-60^\circ C$ $T_J=85^\circ C$ $T_J=230^\circ C$	1.75 1.25 0.95	2.2 1.6 1.2		A
Gate threshold voltage $V_{GS(th)}$	$V_{DS}=V_{GS}, I_{DS}=1mA$ $T_C=-60^\circ C$ $T_C=85^\circ C$ $T_C=230^\circ C$		1.76 1.38 0.89		V
Temperature drift of gate threshold voltage $\Delta V_{GS(th)}/\Delta T_j$	$V_{DS}=V_{GS}, I_{DS}=1mA$		-3.0		mV/°C
Off-state drain current $I_{DSS}$	$V_{DS}=40V, V_{GS}=0V$ $T_C=85^\circ C$ $T_C=230^\circ C$		0.01 13	0.5 60	μA
Gate Leakage current $I_{GSS}$	$V_{GS}=\pm 5V, V_{DS}=0V$ $T_C=85^\circ C$ $T_C=230^\circ C$		±0.6 ±130	±5 ±1000	nA
<b>AC Characteristics</b>					
Input capacitance $C_{iss}$	$V_{DS}=32V, V_{GS}=0V, f=1MHz$		390		pF
Output capacitance $C_{oss}$			80		pF
Transfer capacitance $C_{rss}$			65		pF
<b>Switching Characteristics</b>					
Pulsed drain current $I_{DM}$	$V_{DS}=20V, V_{GS\ sweep}=0$ to +5V, $d=0.2\%, \tau=1ms$ $T_C=-60^\circ C$ $T_C=85^\circ C$ $T_C=230^\circ C$	7.0 5.0 3.8	8.8 6.2 4.7		A
Total gate charge $Q_g$	$V_{DS}=20V, V_{GS\ sweep}=0$ to +5V		5.4		nC
Turn-on delay time $t_{d(on)}$	$V_{DS}=20V, V_{GS\ sweep}=0$ to +5V, $R_D=47\Omega, d=0.2\%, \tau=1ms$		11		ns
Rise time $t_r$	$V_{DS}=20V, V_{GS\ sweep}=0$ to +5V, $R_D=47\Omega, d=0.2\%, \tau=1ms$		14		
Turn-off delay time $t_{d(off)}$	$V_{DS}=20V, V_{GS\ sweep}=0$ to +5V, $R_D=47\Omega, d=0.2\%, \tau=1ms$		29		
Fall time $t_f$	$V_{DS}=20V, V_{GS\ sweep}=0$ to +5V, $R_D=47\Omega, d=0.2\%, \tau=1ms$		27		
<b>Drain-Source Diode Characteristics</b>					
Forward diode voltage $V_{SD\_1A}$	$V_{GS}=0V, I_{DS}=-1A$ $T_C=-60^\circ C$ $T_C=85^\circ C$ $T_C=230^\circ C$		1.10 0.97 0.89		V

**XTR2N0450 SPECIFICATIONS**

 Unless otherwise stated, specification applies for  $-60^{\circ}\text{C} < T_j < 230^{\circ}\text{C}$ .

Parameter	Condition	Min	Typ	Max	Units
<b>DC Characteristics</b>					
Drain-source breakdown voltage $BV_{DSS}$	$V_{GS}=0\text{V}, I_{DS}=100\mu\text{A}$	55			V
Static drain-source on-state resistance $R_{DS(on)}$	$V_{GS}=+5\text{V}, I_{DS}=100\text{mA}$ $T_C=-60^{\circ}\text{C}$ $T_C=85^{\circ}\text{C}$ $T_C=230^{\circ}\text{C}$		105 165 255	130 200 310	$\text{m}\Omega$
Continuous drain current $I_{D(DC)}$	$V_{GS}=+5\text{V}$ for TO-257 $T_J=-60^{\circ}\text{C}$ $T_J=85^{\circ}\text{C}$ $T_J=230^{\circ}\text{C}$	3.8 2.7 2.1	4.8 3.4 2.6		A
Gate threshold voltage $V_{GS(th)}$	$V_{DS}=V_{GS}, I_{DS}=1\text{mA}$ $T_C=-60^{\circ}\text{C}$ $T_C=85^{\circ}\text{C}$ $T_C=230^{\circ}\text{C}$		1.72 1.32 0.79		V
Temperature drift of gate threshold voltage $\Delta V_{GS(th)}/\Delta T_j$	$V_{DS}=V_{GS}, I_{DS}=1\text{mA}$		-3.2		$\text{mV}/^{\circ}\text{C}$
Off-state drain current $I_{DSS}$	$V_{DS}=40\text{V}, V_{GS}=0\text{V}$ $T_C=85^{\circ}\text{C}$ $T_C=230^{\circ}\text{C}$		0.02 30	1 150	$\mu\text{A}$
Gate Leakage current $I_{GSS}$	$V_{GS}=\pm 5\text{V}, V_{DS}=0\text{V}$ $T_C=85^{\circ}\text{C}$ $T_C=230^{\circ}\text{C}$		$\pm 0.8$ $\pm 160$	$\pm 5$ $\pm 1000$	nA
<b>AC Characteristics</b>					
Input capacitance $C_{iss}$	$V_{DS}=32\text{V}, V_{GS}=0\text{V}, f=1\text{MHz}$		900		pF
Output capacitance $C_{oss}$			180		pF
Transfer capacitance $C_{rss}$			150		pF
<b>Switching Characteristics</b>					
Pulsed drain current $I_{DM}$	$V_{DS}=20\text{V}, V_{GS \text{ sweep}}=0$ to +5V, $d=0.2\%$ , $\tau=1\text{ms}$ $T_C=-60^{\circ}\text{C}$ $T_C=85^{\circ}\text{C}$ $T_C=230^{\circ}\text{C}$	15.5 10.9 8.3	19.4 13.6 10.3		A
Total gate charge $Q_g$	$V_{DS}=20\text{V}, V_{GS \text{ sweep}}=0$ to +5V		12.2		nC
Turn-on delay time $t_{d(on)}$	$V_{DS}=20\text{V}, V_{GS \text{ sweep}}=0$ to +5V, $R_D=47\Omega, d=0.2\%$ , $\tau=1\text{ms}$		13		ns
Rise time $t_r$	$V_{DS}=20\text{V}, V_{GS \text{ sweep}}=0$ to +5V, $R_D=47\Omega, d=0.2\%$ , $\tau=1\text{ms}$		17		
Turn-off delay time $t_{d(off)}$	$V_{DS}=20\text{V}, V_{GS \text{ sweep}}=0$ to +5V, $R_D=47\Omega, d=0.2\%$ , $\tau=1\text{ms}$		35		
Fall time $t_f$	$V_{DS}=20\text{V}, V_{GS \text{ sweep}}=0$ to +5V, $R_D=47\Omega, d=0.2\%$ , $\tau=1\text{ms}$		33		
<b>Drain-Source Diode Characteristics</b>					
Forward diode voltage $V_{SD-1A}$	$V_{GS}=0\text{V}, I_{DS}=-1\text{A}$ $T_C=-60^{\circ}\text{C}$ $T_C=85^{\circ}\text{C}$ $T_C=230^{\circ}\text{C}$		1.00 0.88 0.66		V

## XTR2N0425 TYPICAL PERFORMANCE

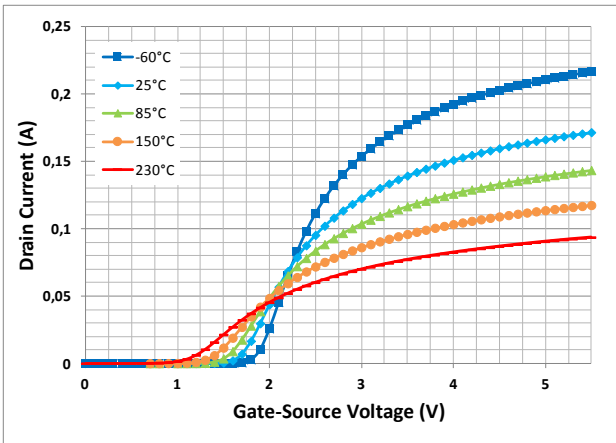

Figure 1. Drain Current ( $I_{DS}$ ) vs Gate-Source Voltage for several case temperatures.  $V_{DS}=50mV$ .

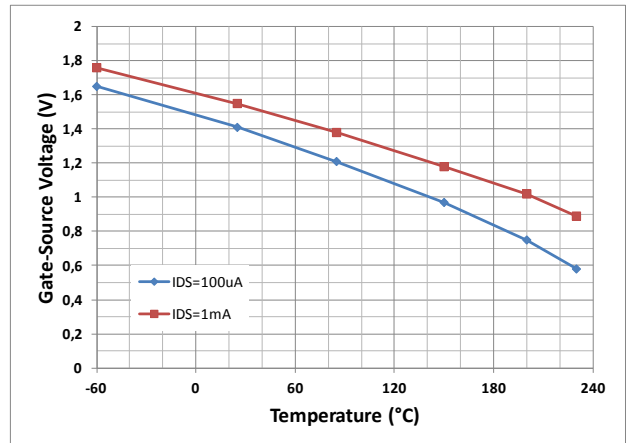

Figure 2. Gate-Source Threshold Voltage ( $V_{GS(th)}$ ) vs Gate-Source Voltage for several case temperatures.  $V_{GS}=V_{DS}$ .

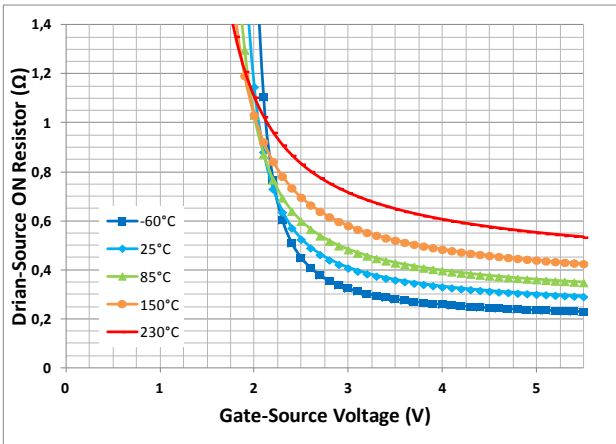

Figure 3. Drain-Source ON Resistance ( $R_{DS(on)}$ ) vs Gate-Source Voltage for several case temperatures.  $V_{DS}=50mV$ .

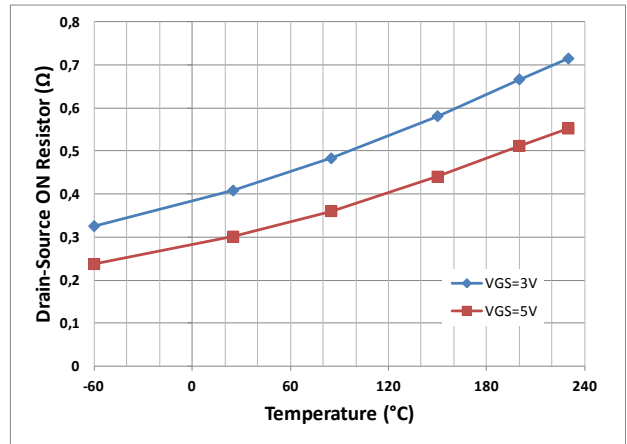

Figure 4. Drain-Source ON Resistance ( $R_{DS(on)}$ ) vs Case Temperature.  $V_{DS}=50mV$ .

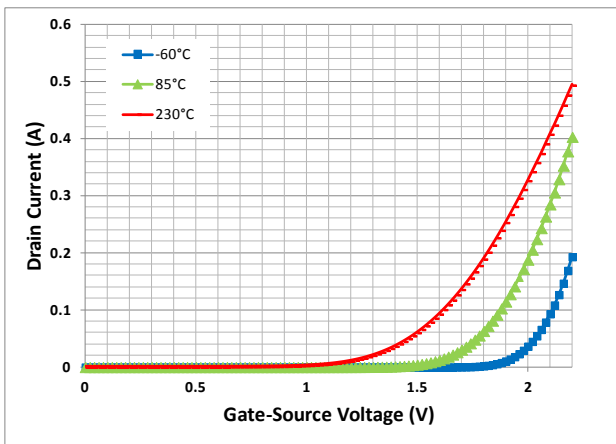

Figure 5. Drain Current ( $I_{DS}$ ) vs Gate-Source Voltage for several case temperatures.  $V_{GS}=V_{DS}$

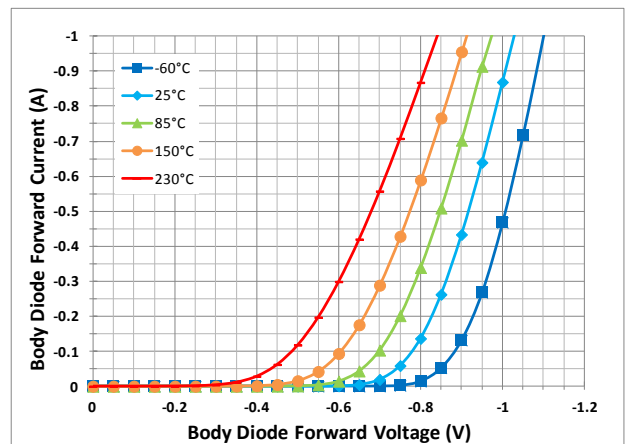

Figure 6. Body Diode Forward Current ( $I_{FD}$ ) vs Forward Voltage for several case temperature.  $V_{GS}=0V$ .

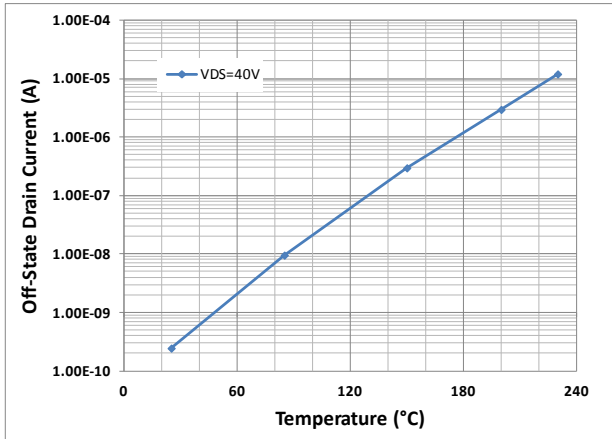

Figure 7. Off-State Drain Current ( $I_{DSS}$ ) vs Case Temperature.  $V_{DS}=40V$ ,  $V_{GS}=0V$ .

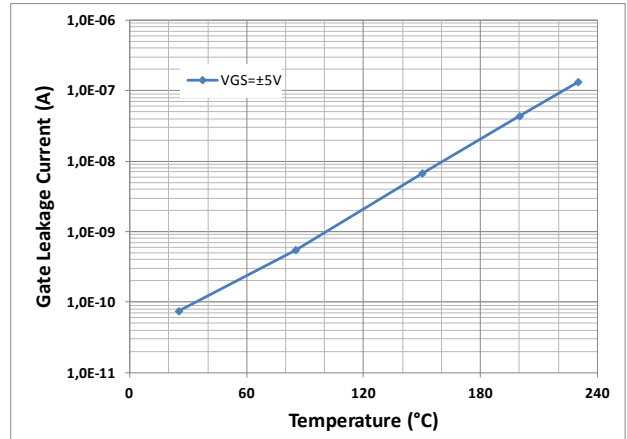

Figure 8. Gate Leakage Current ( $I_{GSS}$ ) vs Case Temperature.  $V_{GS}=\pm 5V$ ,  $V_{DS}=0V$ .

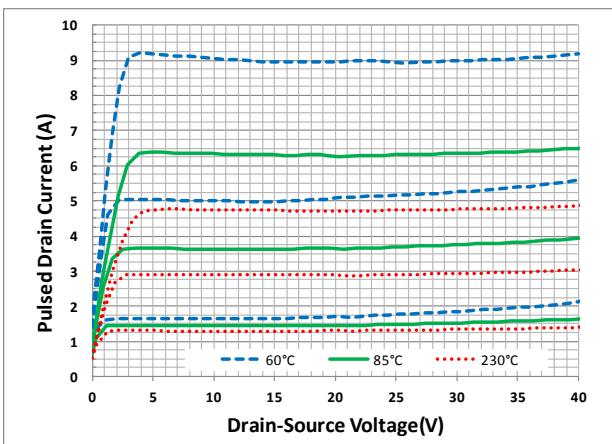

Figure 9. Pulsed Drain Current ( $I_{DM}$ ) vs Drain-Source Voltage for several case temperatures.  $V_{GS}=3V$ ,  $4V$  and  $5V$ .

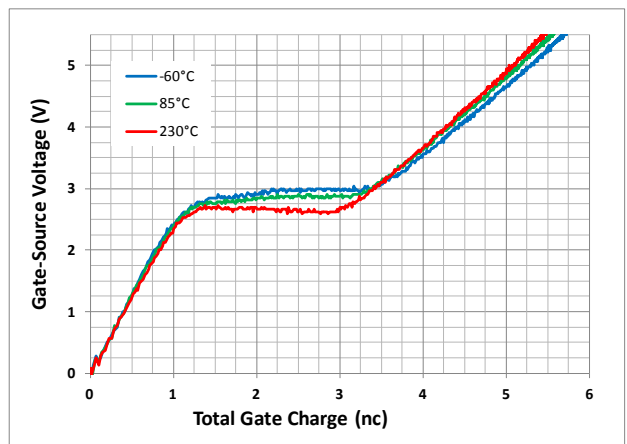

Figure 10. Total Gate Charge ( $Q_g$ ) vs Gate-Source Voltage for several case temperatures.  $I_{DS}=900mA$ .

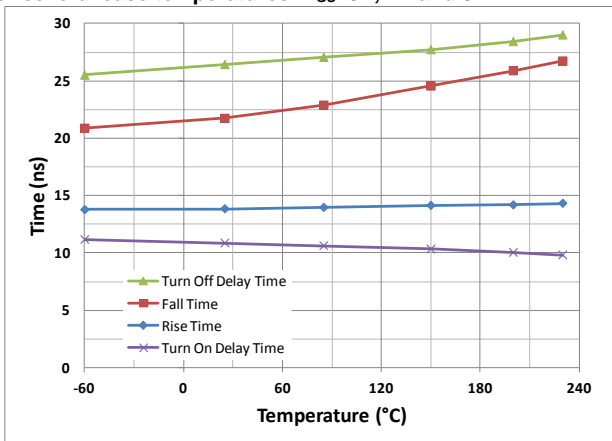

Figure 11. Timing Characteristics vs Case Temperature.  $V_{DS}=20V$ ,  $V_{GS}$  sweep = 0 to 5V.

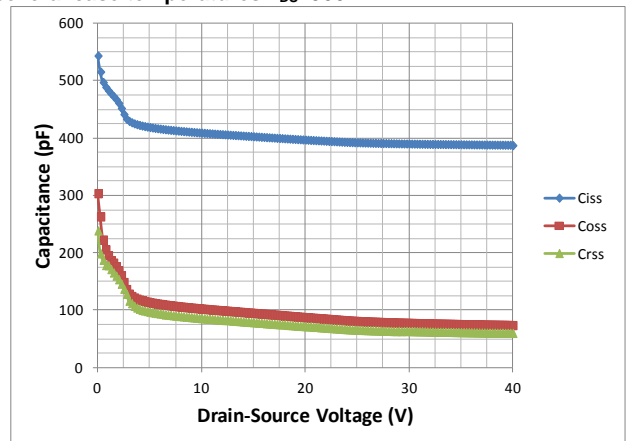

Figure 12. Capacitance vs Drain-Source Voltage at  $T_c=25^\circ C$ .

## XTR2N0450 TYPICAL PERFORMANCE

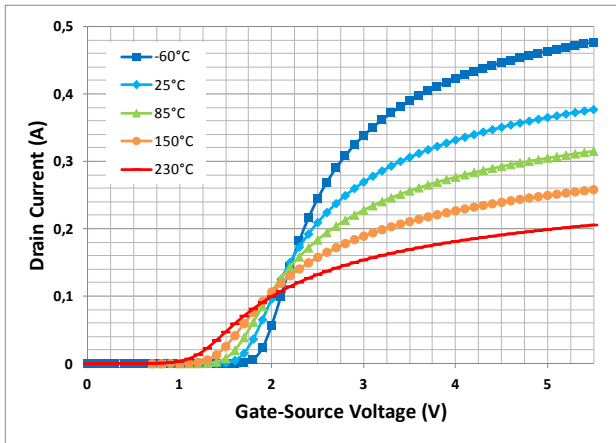

Figure 13. Drain Current ( $I_{DS}$ ) vs Gate-Source Voltage for several case temperatures.  $V_{DS}=50mV$ .

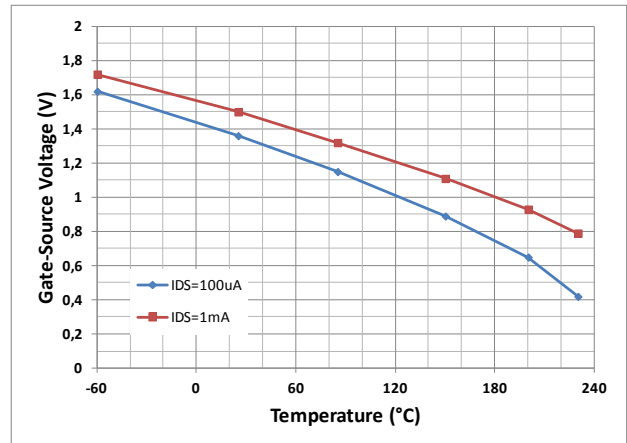

Figure 14. Gate-Source Threshold Voltage ( $V_{GS(th)}$ ) vs Case Temperature.  $V_{GS}=V_{DS}$ .

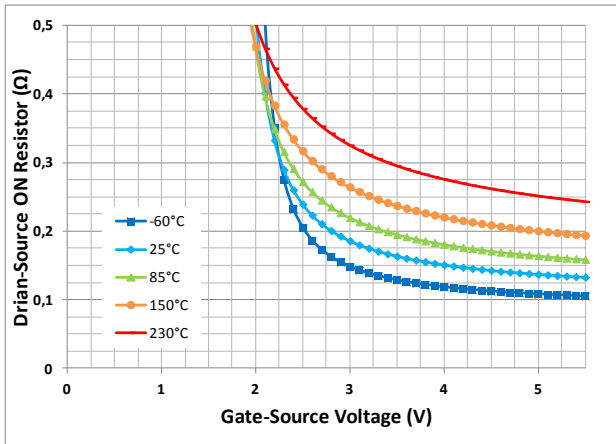

Figure 15. Drain-Source ON Resistance ( $R_{DS(on)}$ ) vs Gate-Source Voltage for several case temperatures.  $V_{DS}=50mV$ .

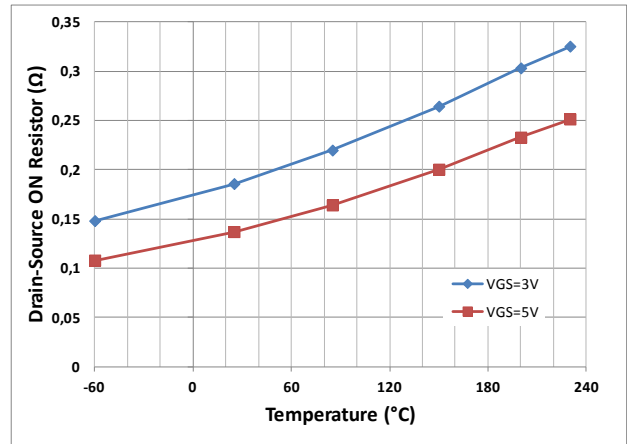

Figure 16. Drain-Source ON Resistance ( $R_{DS(on)}$ ) vs Case Temperature.  $V_{DS}=50mV$ .

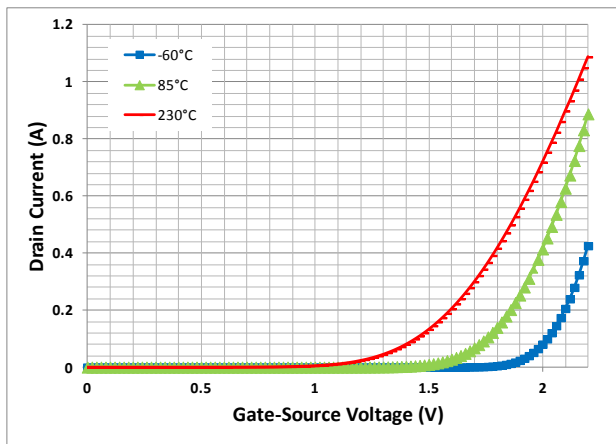

Figure 17. Drain Current ( $I_{DS}$ ) vs Gate-Source Voltage for several case temperatures.  $V_{GS}=V_{DS}$

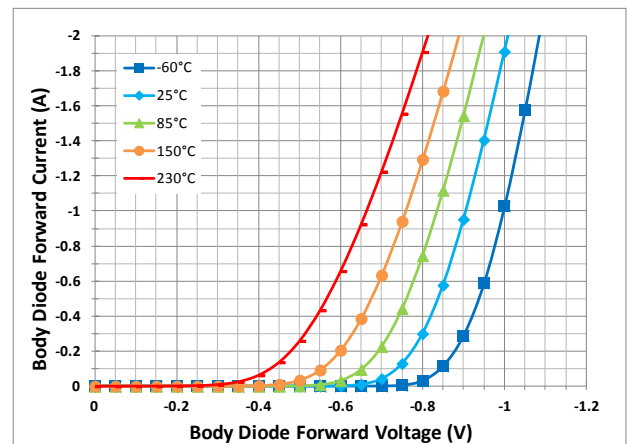

Figure 18. Body Diode Forward Current ( $I_{FD}$ ) vs Forward Voltage for several case temperature.  $V_{GS}=0V$ .

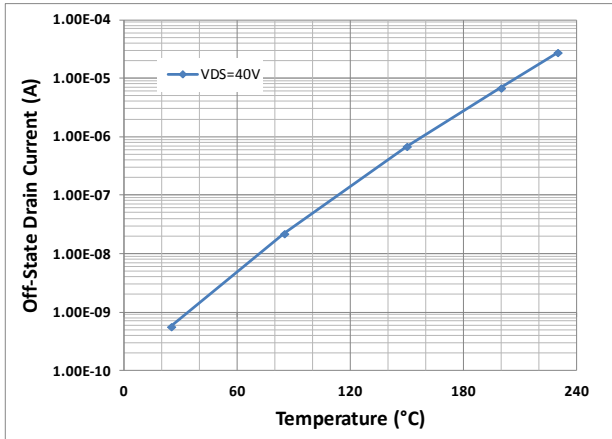

Figure 19. Off-State Drain Current ( $I_{DSS}$ ) vs Case Temperature.  $V_{DS}=40V$ ,  $V_{GS}=0V$ .

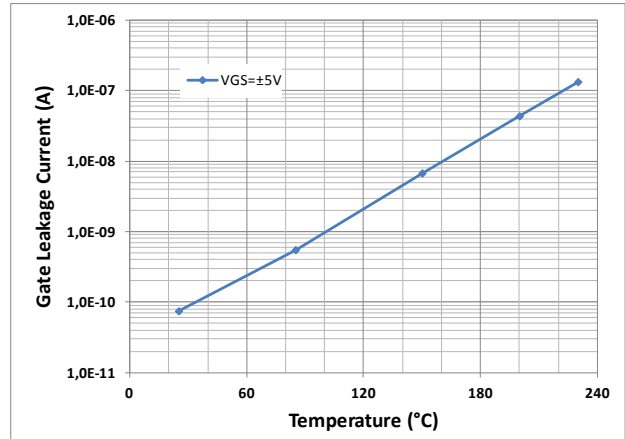

Figure 20. Gate Leakage Current ( $I_{GSS}$ ) vs Case Temperature.  $V_{GS}=\pm 5V$ ,  $V_{DS}=0V$ .

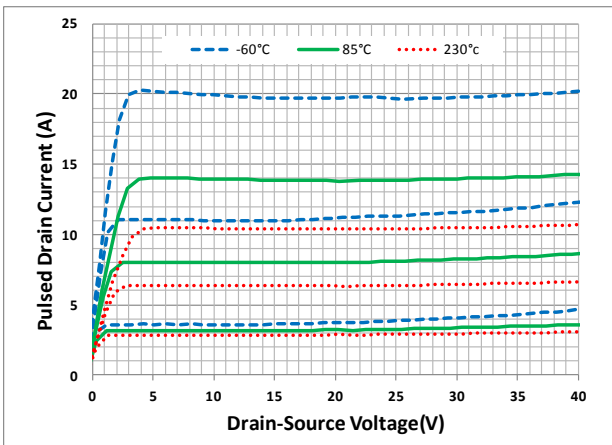

Figure 21. Pulsed Drain Current ( $I_{DM}$ ) vs Drain-Source Voltage for several case temperatures.  $V_{GS}=3V$ ,  $4V$  and  $5V$ .

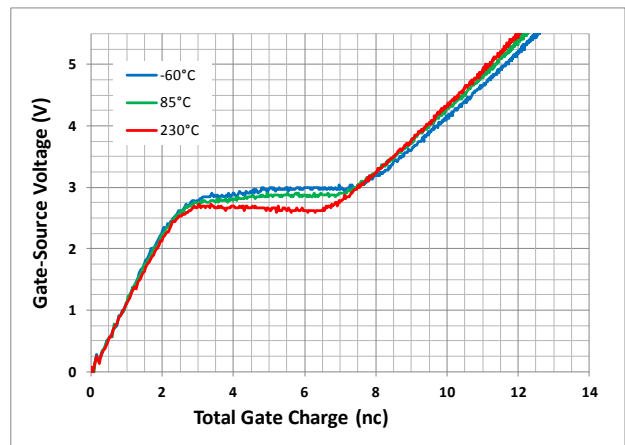

Figure 22. Total Gate Charge ( $Q_g$ ) vs Gate-Source Voltage for several case temperatures.  $I_D=900mA$ .

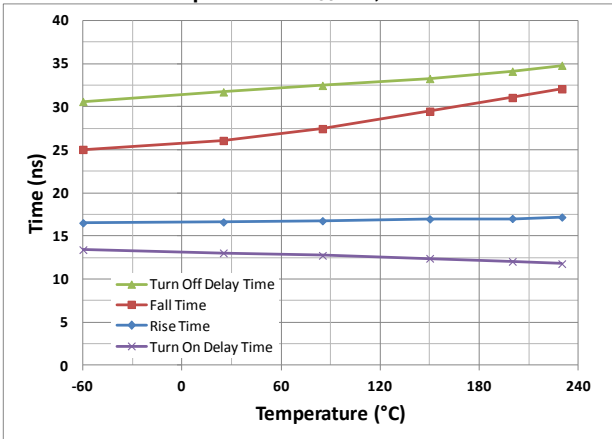

Figure 23. Timing Characteristics vs Case Temperature.  $V_{DS}=20V$ ,  $V_{GS\ sweep}=0$  to  $5V$ .

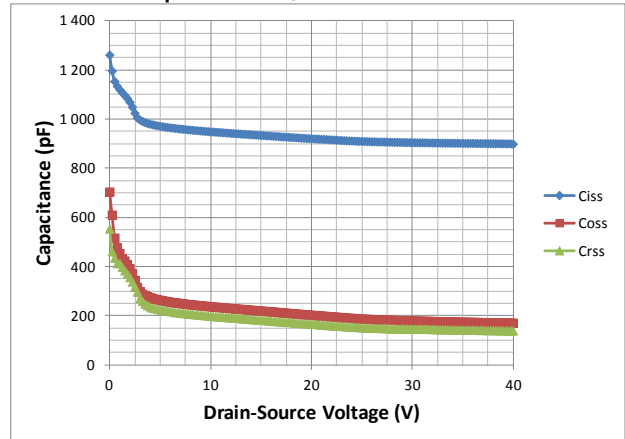

Figure 24. Capacitance vs Drain-Source Voltage at  $T_c=25^\circ C$ .



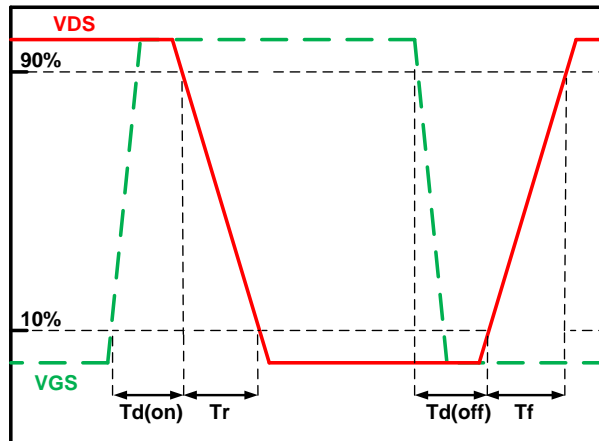
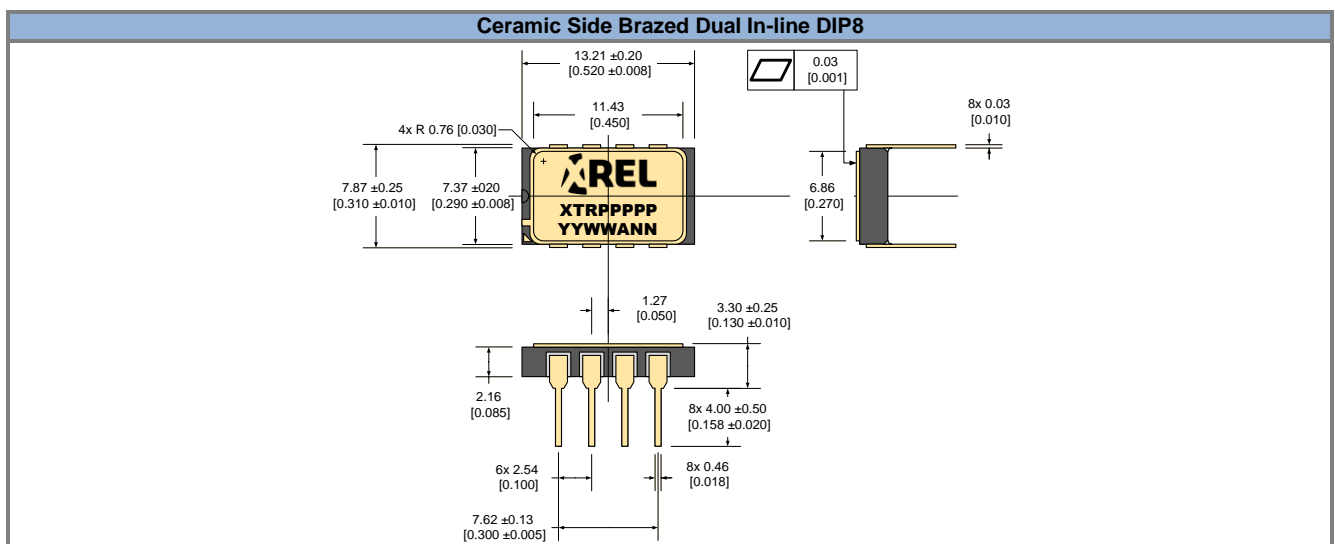
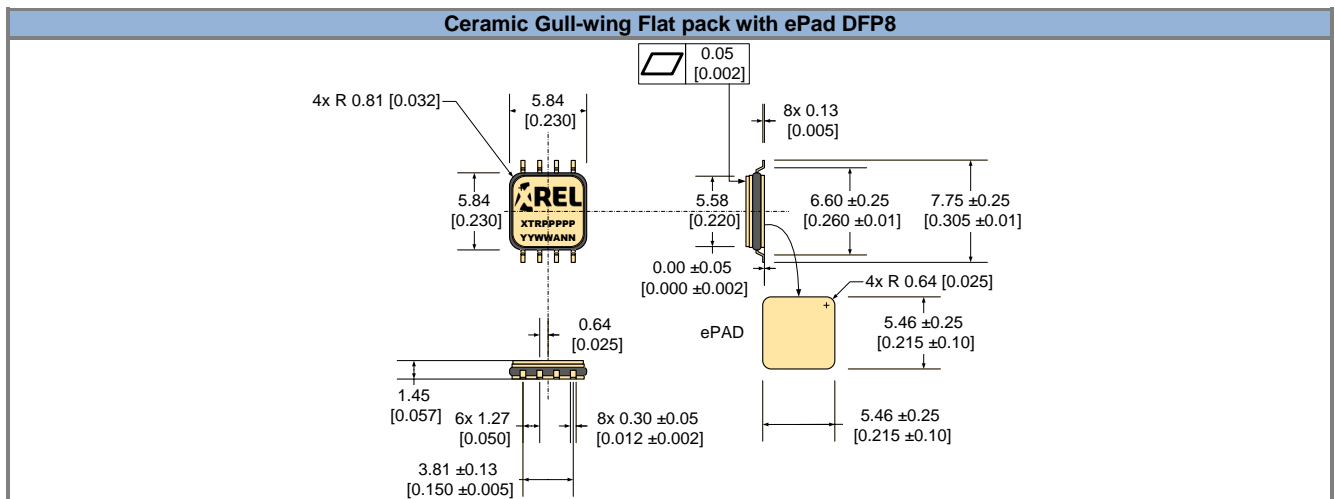
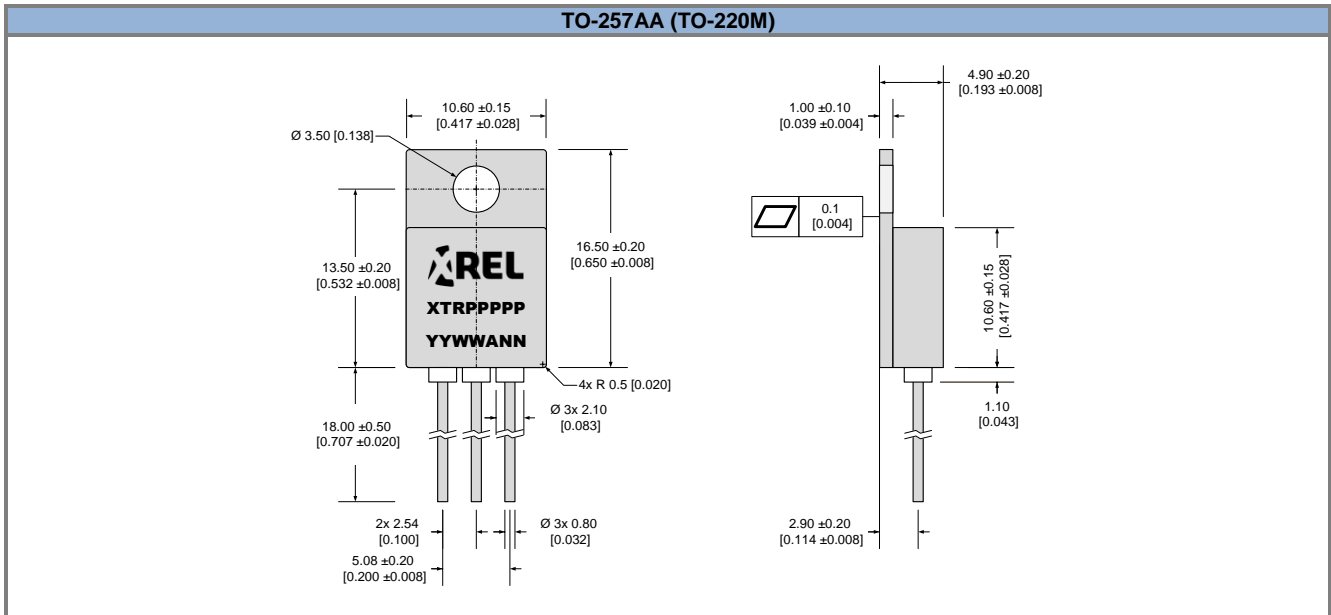

Figure 25. Timing diagram definition.

## PACKAGE OUTLINES

Dimensions shown in mm [inches]. Tolerances  $\pm 0.13$  mm [ $\pm 0.005$  in] unless otherwise stated.





Part Marking Convention	
<b>Part Reference: XTRPPPPP</b>	
<b>XTR</b>	X-REL Semiconductor, high-temperature, high-reliability product (XTRM Series).
<b>PPPPP</b>	Part number (0-9, A-Z).
<b>Unique Lot Assembly Code: YYWWANN</b>	
<b>YY</b>	Two last digits of assembly year (e.g. 15 = 2015).
<b>WW</b>	Assembly week (01 to 52).
<b>A</b>	Assembly location code.
<b>NN</b>	Assembly lot code (01 to 99).

## IMPORTANT NOTICE & DISCLAIMER

Information in this document supersedes and replaces all information previously supplied. Information in this document is provided solely in connection with X-REL Semiconductor products.

The information contained herein is believed to be reliable. X-REL Semiconductor makes no warranties regarding the information contained herein. X-REL Semiconductor assumes no responsibility or liability whatsoever for any of the information contained herein. X-REL Semiconductor assumes no responsibility or liability whatsoever for the use of the information contained herein. The information contained herein is provided "AS IS, WHERE IS" and with all faults, and the entire risk associated with such information is entirely with the user. X-REL Semiconductor reserves the right to make changes, corrections, modifications or improvements, to this document and the information herein without notice. Customers should obtain and verify the latest relevant information before placing orders for X-REL Semiconductor products. The information contained herein or any use of such information does not grant, explicitly or implicitly, to any party any patent rights, licenses, or any other intellectual property rights, whether with regard to such information itself or anything described by such information.

Unless expressly approved in writing by an authorized representative of X-REL Semiconductor, X-REL Semiconductor products are not designed, authorized or warranted for use in military, aircraft, space, life saving, or life sustaining applications, nor in products or systems where failure or malfunction may result in personal injury, death, or property or environmental damage.

General Sales Terms & Conditions apply.

## CONTACT US

For more information on X-REL Semiconductor's products, technical support or ordering:

- ✓ Web: [www.x-relsemi.com/products](http://www.x-relsemi.com/products)
- ✓ Tel: +33 456 580 580
- ✓ Fax: +33 456 580 599
- ✓ Sales: [sales@x-relsemi.com](mailto:sales@x-relsemi.com)  
[www.x-relsemi.com/EN/Sales-Representatives](http://www.x-relsemi.com/EN/Sales-Representatives)
- ✓ Information: [info@x-relsemi.com](mailto:info@x-relsemi.com)
- ✓ Support: [support@x-relsemi.com](mailto:support@x-relsemi.com)

**X-REL Semiconductor**  
90, Avenue Léon Blum  
38100 Grenoble  
France