

THIS IS ISSUED IN STRICT CONFIDENCE ON THE CONDITION THAT IT IS NOT USED AS A BASIS FOR MANUFACTURE OR SALE, AND THAT IT IS NOT COPIED, REPRINTED OR DISCLOSED TO ANY THIRD PARTY WITHOUT THE PRIOR WRITTEN CONSENT OF MIN-E-CON

UNLESS OTHERWISE SPECIFIED ALL DIMENSIONS ARE IN INCHES DRAWING STANDARDS ARE PER ANSI Y14.5M-1982

THIRD ANGLE PROJECTION

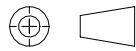

REVISIONS				
ECO	REV	DESCRIPTION	DATE	APPROVED
	A	RELEASE	4/7/10	WC

NOTES:

- ALL TOLERANCES ±.010" UNLESS OTHERWISE SPECIFIED
- CONNECTOR INTERFACE PER MIL-DTL-83513/8D (PLUG CLASS P CRIMP TYPE)
- MATERIAL:
  - A) INSULATOR AND BOX: POLYPHENYLENE SULFIDE (RYTON).
  - B) SHELL: ALUMINUM ALLOY 6061-T6 HARD ANODIZE, COLOR: BLACK.
  - C) CONTACT PLATING: GOLD OVER NICKEL, 50 TO 150 MICROINCHES PER MIL-G-45204, TYPE II, CLASS 1, GRADE C.
  - D) EPOXY: HI-TEMPERATURE, 200°C.
  - E) WIRE: 24 AWG SOLID COPPER PER A-A-59551 (FORMERLY QQ-W-343) PLATED GOLD OVER NICKEL, 20 TO 50 MICROINCHES PER MIL-G-45204, TYPE II, CLASS 1, GRADE C.
  - F) THREADED INSERT (OPTIONAL): 300 SERIES STAINLESS STEEL
- CONNECTOR RATED TO 200°C.

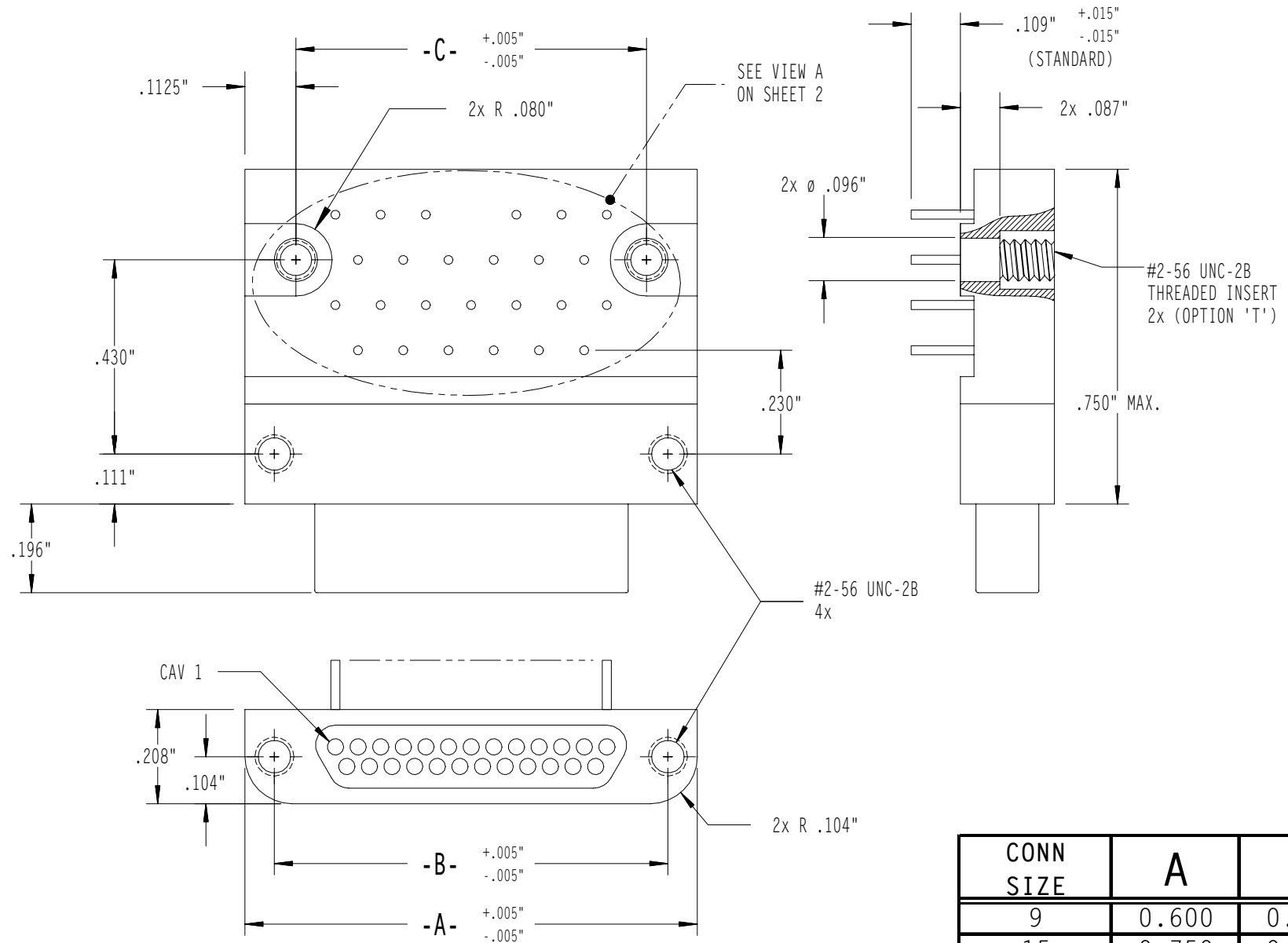

PART NUMBER CONSTRUCTION

DNBR-XX P CBR T -Ø.140 /Ø1

# OF CONTACTS  
9, 15, 21,  
25, 31, 37

CONTACT TYPE  
P = PIN

BOARD STYLE  
CBR = CIRCUIT BOARD  
RIGHT-ANGLE

MODIFICATION CODE  
/Ø1 = HI-TEMP (200C)

TERMINATION WIRE LENGTH (INCHES)  
AVAILABLE LENGTHS  
0.109", 0.140", 0.172"  
(LEAVING BLANK = STANDARD 0.109")

BOARD-MOUNT HARDWARE (OPTIONAL)  
T = #2-56 THREADED INSERT  
(OMIT FOR THRU HOLE)

CONN SIZE	A	B	C
9	0.600	0.470	0.375
15	0.750	0.620	0.525
21	0.900	0.770	0.675
25	1.000	0.870	0.775
31	1.150	1.020	0.925
37	1.300	1.170	1.075

INTENDED USE CUSTOMER USE			17312 EASTMAN IRVINE, CA 92614		
REFERENCE			DWG TITLE CONN, PLUG, DNBR SERIES LOW PROFILE CBR		
SIGNATURES	DATE	SIZE	FSCM NO.	DWG NO.	REV
DRAWN CHARETTE	4/7/10	B	54455	00-005-0022	A
CHECKED WC	4/7/10	SCALE NONE		SHEET 1 of 2	
APPROVED WC	4/7/10				

THIS IS ISSUED IN STRICT CONFIDENCE ON THE CONDITION THAT IT IS NOT USED AS A BASIS FOR MANUFACTURE OR SALE, AND THAT IT IS NOT COPIED, REPRINTED OR DISCLOSED TO ANY THIRD PARTY WITHOUT THE PRIOR WRITTEN CONSENT OF MIN-E-CON

UNLESS OTHERWISE SPECIFIED ALL DIMENSIONS ARE IN INCHES DRAWING STANDARDS ARE PER ANSI Y14.5M-1982

THIRD ANGLE PROJECTION

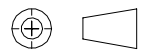

REVISIONS				
ECO	REV	DESCRIPTION	DATE	APPROVED
	A	SEE SHEET 1		

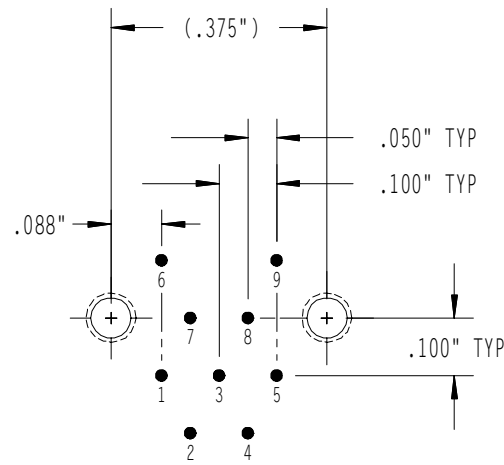

**SIZE 9**

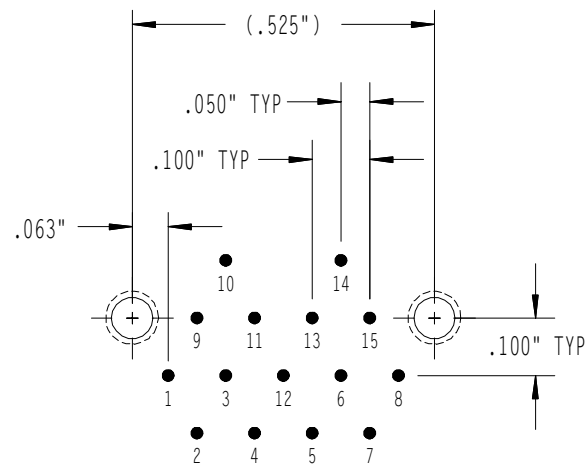

**SIZE 15**

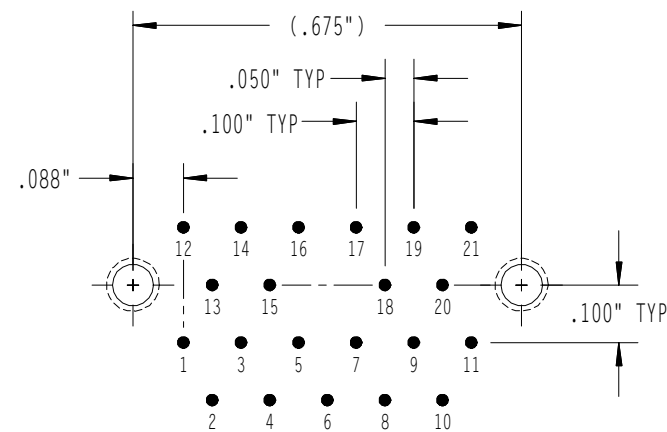

**SIZE 21**

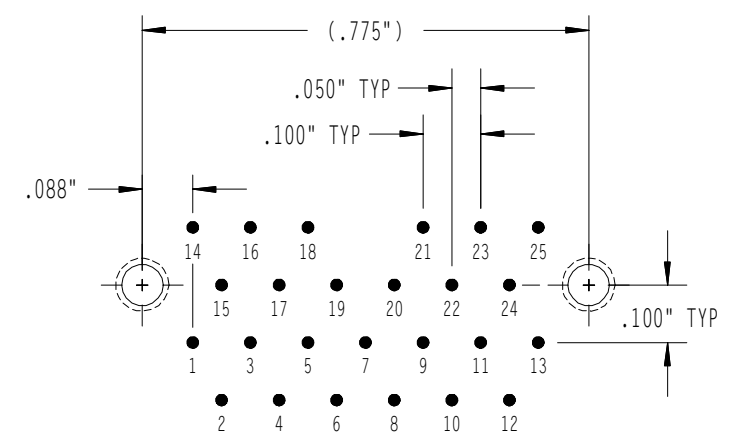

**SIZE 25**

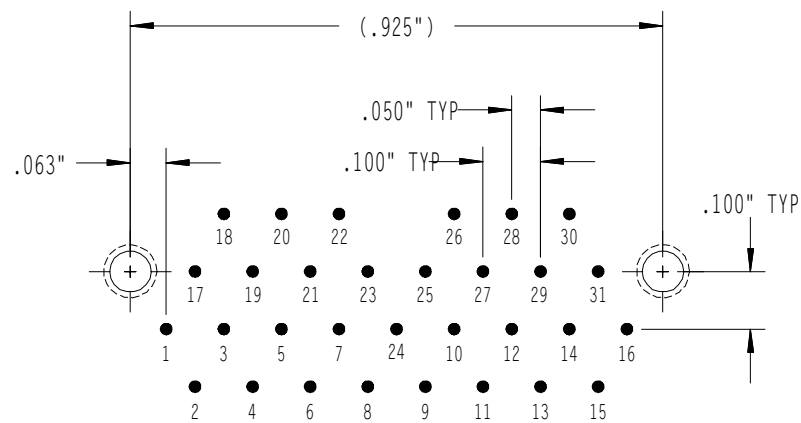

**SIZE 31**

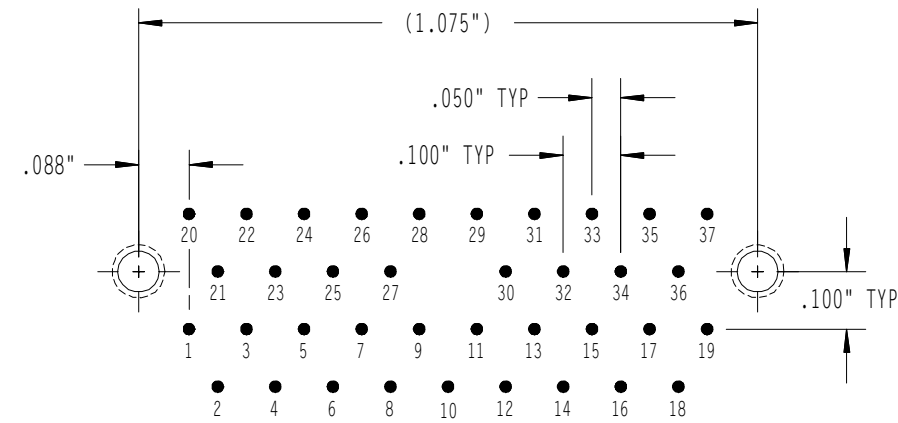

**SIZE 37**

**VIEW A**

CIRCUIT NUMBERS ARE FOR REFERENCE ONLY AND DO NOT APPEAR ON PART

INTENDED USE CUSTOMER USE		 17312 EASTMAN IRVINE, CA 92614	
REFERENCE			
SIGNATURES		DWG TITLE	
DRAWN	DATE	CONN, PLUG, DNBR SERIES LOW PROFILE CBR	
CHARETTE	4/7/10	SIZE	FSCM NO.
CHECKED	4/7/10	B	54455
APPROVED	4/7/10	DWG NO.	00-005-0022
WC		REV	A
WC		SCALE	NONE
		SHEET	2 of 2